

14歳女子シングルス(3/16ドロ-版)

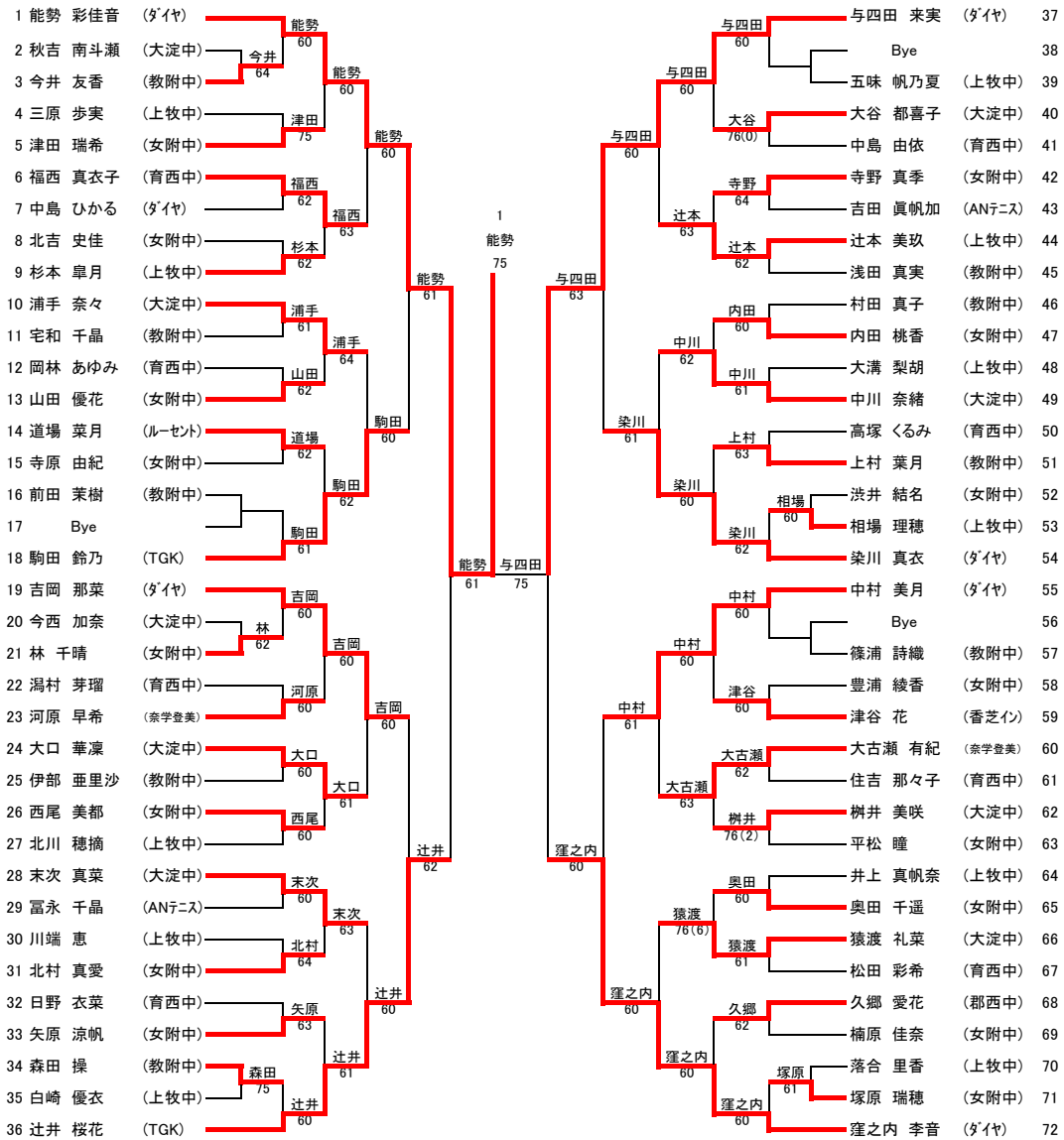

3位決定戦

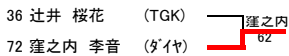

5~8位決定戦

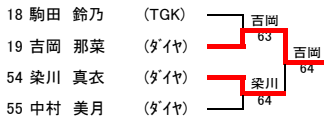

7位決定戦

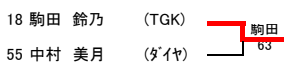

9~16位決定戦

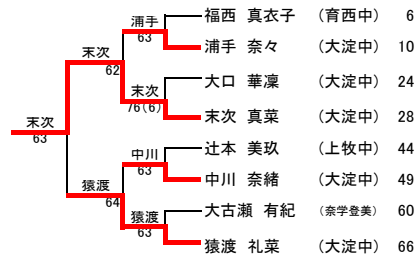

11位決定戦(タイブレーク)

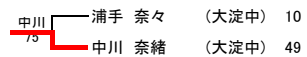

13~16位決定戦(タイブレーク)

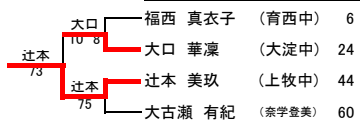

15位決定戦

